



# Technical Data

Specification & Capacities



## SPX1275CDH

S.N: \_\_\_\_\_



26,9kW/36,0Hp



4,9-17,7m



7500kg



EN 13000

[m] [kg]



***SPX1275***



Via Campardone, 1  
31014 Colle Umberto – Italy  
Tel. +39 0438 1710083  
Mail: info@jekko.it  
Web: www.jekko.it

Date	Mar. 31 <sup>st</sup> 2016
REV.	16

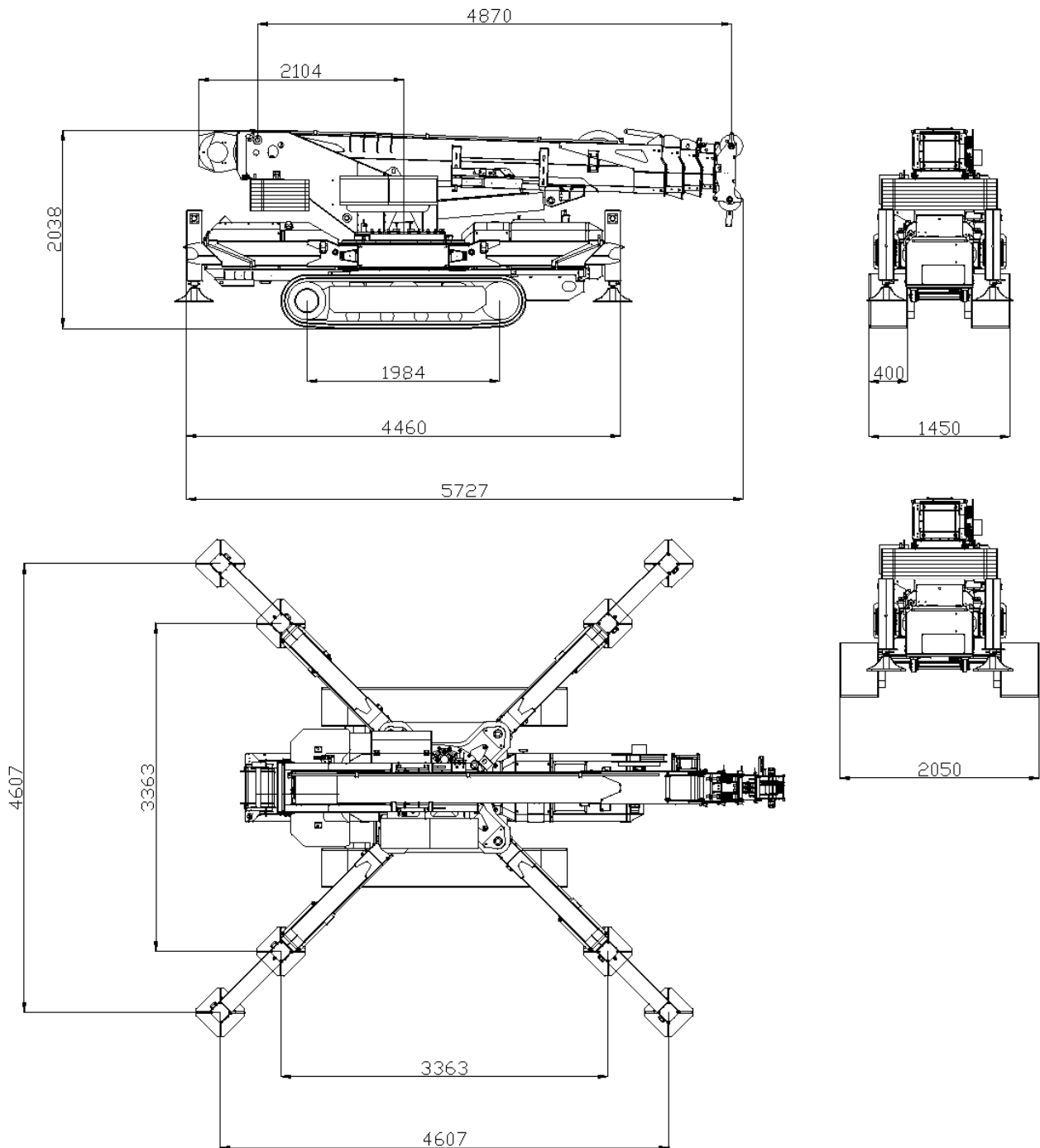
**SPX1275CDH - OVERALL DIMENSIONS**

		kg
		6800
		1500
<b>Tot.</b>		<b>8300</b>

	km/h	1,6 / 3,1
	20°	
	kg/cm <sup>2</sup>	0,72
	kg	6800

	0°/75°	
	360°	1,0 rpm
	m	4,9 - 17,7

	ISUZU 3CE1		26,9kW 36,0Hp		
			DIESEL		
			I	20	

**HOIST PERFORMANCE**

Layer	Max Line Pull	Normal Line Speed	High Line Speed
	kg	m/min	m/min
1	2072	46.4	83.5
2	1893	50.7	91.4
3	1743	55.1	99.3
4	1615	59.5	107.2
5	1504	63.8	115.1

(\*) 1500kg LMI limited

Wire Rope	Diameter	Tot. Length	Max Load
	mm	m	kg
Right lang lay	10	125	9480

**HOOK BLOCK**

LOAD	No. of	
	Sheaves	Lines
7500	3	6
7500	3	5
6000	2	4
4500	2	3
3000	1	2
1500	-	1







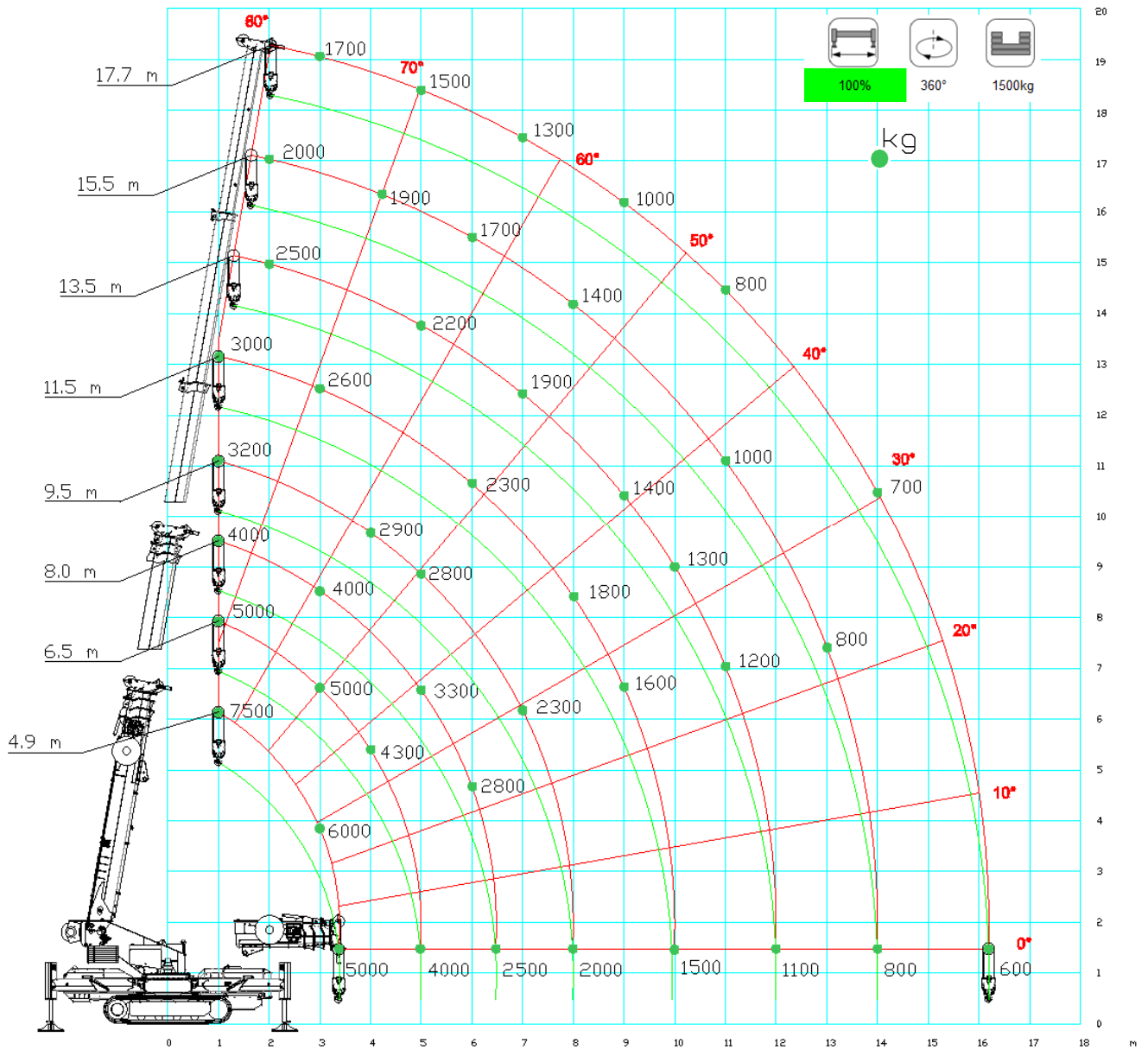

***SPX1275***







## SPX1275CDH – MAIN BOOM









[m] [kg]																	
	100%		360°	1500kg	4,9	5,5	6,5	8,0	8,1	8,5	9,5	10,5	11,5	13,5	14,5	16,5	17,7
1,0	7500	6500	5000	4000	3700	3500	3200										
2,0	7500	6500	5000	4000	3700	3400	3200	3000	2800	2500	2300						
3,0	6000	5600	5000	4000	3600	3300	3000	2800	2600	2400	2300	1800	1700				
3,4	5000	4900	4600	4000	3500	3300	3000	2800	2600	2400	2300	1800	1700				
4,0		4800	4300	4000	3400	3200	2900	2700	2600	2300	2300	1800	1700				
5,0			4000	3300	3100	3100	2800	2600	2500	2200	2100	1700	1500				
6,0				2800	2700	2700	2600	2400	2300	2000	1800	1600	1400				
6,5				2500	2500	2500	2400	2200	2100	1900	1700	1500	1300				
6,6					2500	2500	2400	2200	2100	1900	1700	1500	1300				
7,0						2400	2300	2200	2100	1900	1700	1400	1300				
8,0							2000	1900	1800	1600	1500	1300	1200				
9,0								1700	1600	1400	1300	1100	1000				
10,0									1500	1300	1200	1000	900				
11,0											1200	1100	800	800			
12,0												1100	1000	800	700		
13,0													900	700	700		
14,0															700	700	
15,0																700	600
16,2																	600
<b>I° SECTION</b>								<b>CHAIN SECTION</b>									





LC1275\_V200\_0715\_MB\_CW\_1500\_STAB\_100

[m] [kg]														
	50%		360°	1500kg										
	4,9	5,5	6,5	8,0	8,1	8,5	9,5	10,5	11,5	13,5	14,5	16,5	17,7	
1,0	7500	6500	5000	4000	3700	3500	3200							
2,0	7500	6500	5000	4000	3700	3400	3200	3000	2800	2500	2300			
3,0	4200	4000	3600	3000	2800	2700	2600	2500	2400	2200	2000	1500	1400	
3,4	3700	3600	3200	2700	2500	2300	2100	2000	1900	1700	1700	1300	1200	
4,0		3200	2800	2600	2400	2200	2000	1800	1700	1600	1500	1200	1100	
5,0			2500	2000	1800	1800	1800	1700	1600	1500	1400	1000	900	
6,0				1800	1700	1700	1700	1600	1400	1300	1200	1000	900	
6,5				1700	1600	1600	1600	1500	1400	1200	1100	900	800	
6,6					1600	1600	1600	1500	1400	1200	1100	900	800	
7,0						1500	1500	1400	1400	1200	1100	900	800	
8,0							1200	1200	1200	1100	1000	800	800	
9,0								1000	1000	900	900	700	600	
10,0									800	800	700	600	500	
11,0										700	700	400	400	
12,0											600	600	400	400
13,0												500	400	400
14,0													350	300
15,0													350	300
16,2														300

LC1275\_V200\_0715\_MB\_CW\_1500\_STAB\_50

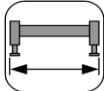
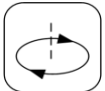
[m] [kg]					EN									
	100%			360°	0kg									
	4,9	5,5	6,5	8,0	8,1	8,5	9,5	10,5	11,5	13,5	14,5	16,5	17,7	
1,0	7500	6000	5000	4000	3700	3500	3200							
2,0	7500	6000	5000	4000	3700	3400	3200	3000	2800	2500	2300			
3,0	4800	4500	3800	3800	3500	3200	2900	2700	2500	2300	2200	1700	1600	
3,4	4000	3900	3800	3700	3300	3000	2800	2600	2400	2200	2100	1600	1500	
4,0		3800	3400	3000	2800	2600	2500	2400	2300	2200	2100	1600	1500	
5,0			3000	2900	2500	2500	2300	2200	2200	2200	2000	1500	1300	
6,0				2200	2200	2200	2200	2100	2000	1800	1600	1400	1200	
6,5				2100	2000	2000	1900	1700	1700	1500	1300	1100	900	
6,6					2000	2000	1900	1700	1700	1500	1300	1000	900	
7,0						1700	1700	1600	1500	1400	1200	900	800	
8,0							1300	1300	1200	1100	1000	800	800	
9,0								1100	1000	900	900	800	700	
10,0									900	800	800	700	600	
11,0										700	600	500	500	
12,0										600	600	500	400	
13,0											500	400	400	
14,0												400	300	
15,0												400	300	
16,2													300	

LC 1275\_V200\_0715\_MB\_CW\_0\_STAB\_100

[m] [kg]												
		50%	360°	0kg								
	4,9	5,5	6,5	7,5	8,0	8,1	8,5	9,5	10,5	11,5	12,5	13,5
1,0	7500	6000	5000	4300	4000	3700	3500	3200				
2,0	7500	6000	5000	4300	4000	3700	3400	3200	3000	2600	2400	2400
3,0	3800	3600	3200	3000	2800	2600	2400	2200	2000	1800	1700	1700
3,4	3000	3000	2900	2600	2500	2400	2200	2000	1800	1600	1400	1400
4,0		2400	2300	2200	2200	2000	1800	1600	1400	1300	1200	1200
5,0			1700	1600	1600	1500	1500	1500	1400	1300	1200	1200
6,0				1200	1200	1200	1100	1100	1100	1000	1000	1000
6,5					1100	1100	1100	1100	1000	1000	1000	900
6,6						1000	1000	1000	900	900	900	800
7,0							900	900	800	800	700	700
8,0								700	700	600	600	500
9,0									600	500	500	500
10,0										500	500	400
11,0											400	400
12,0												300

LC 1275\_V200\_0715\_MB\_CW\_0\_STAB\_50



**SPX1275CDH – MAIN BOOM  
PICK & CARRY**

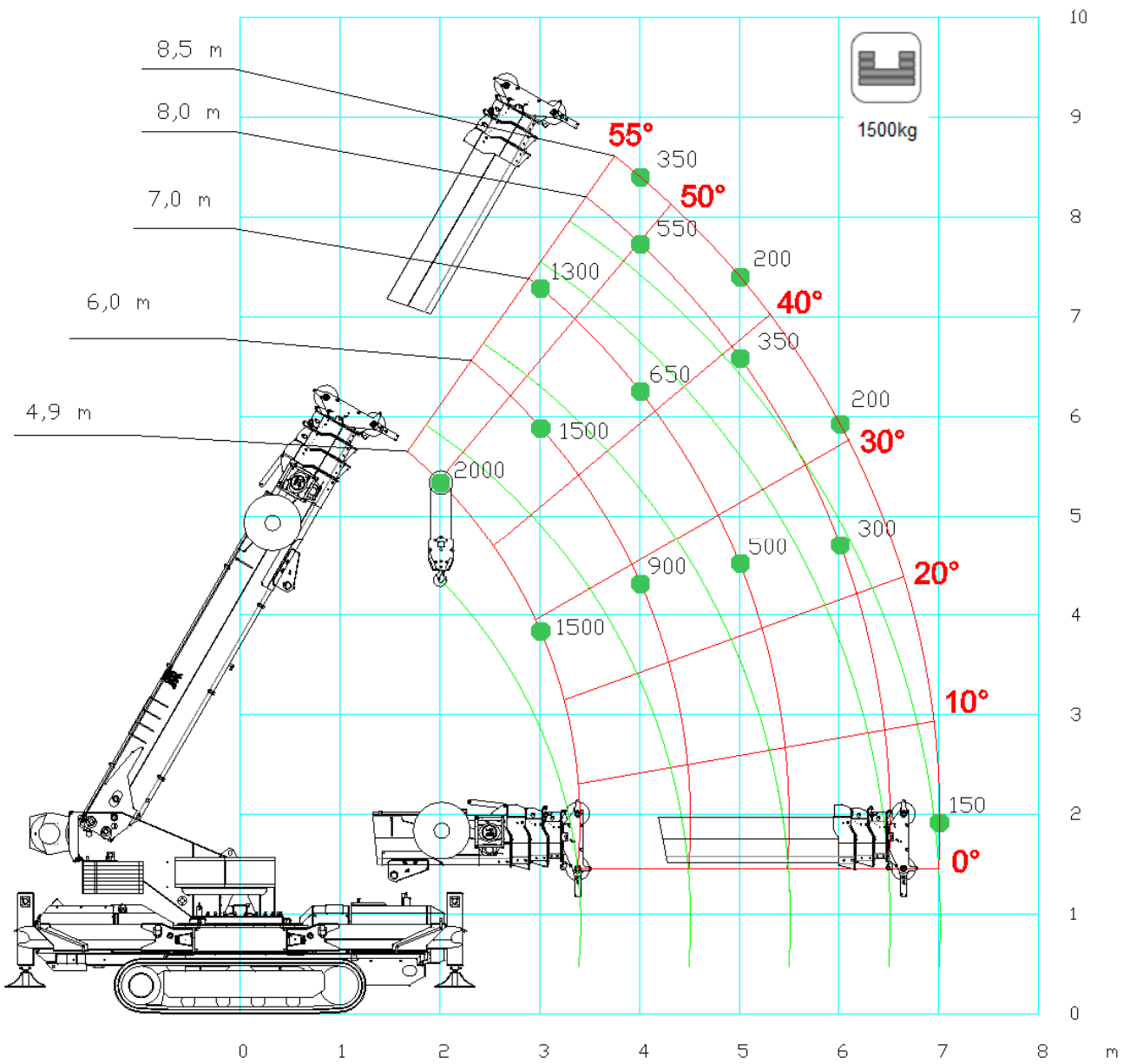

[m] [kg]					EN	
		2050	360°	1500kg		
		4,9	6,0	7,0	8,0	8,5
2,0	2000					
3,0	1500	1500	1300			
4,0		900	650	550	350	
5,0			500	350	200	
6,0				300	200	
7,0					150	

LC1275\_V200\_0715\_MB\_CW\_1500\_CINGOLI



[m] [kg]					EN	
		1450	0°	1500kg		
		4,9	6,0	7,0	8,0	8,5
2,0	2000					
3,0	1500	1500	1300			
4,0		900	650	550	350	
5,0			500	350	200	
6,0				300	200	
7,0					150	

LC1275\_V200\_0715\_MB\_CW\_1500\_CINGOLI

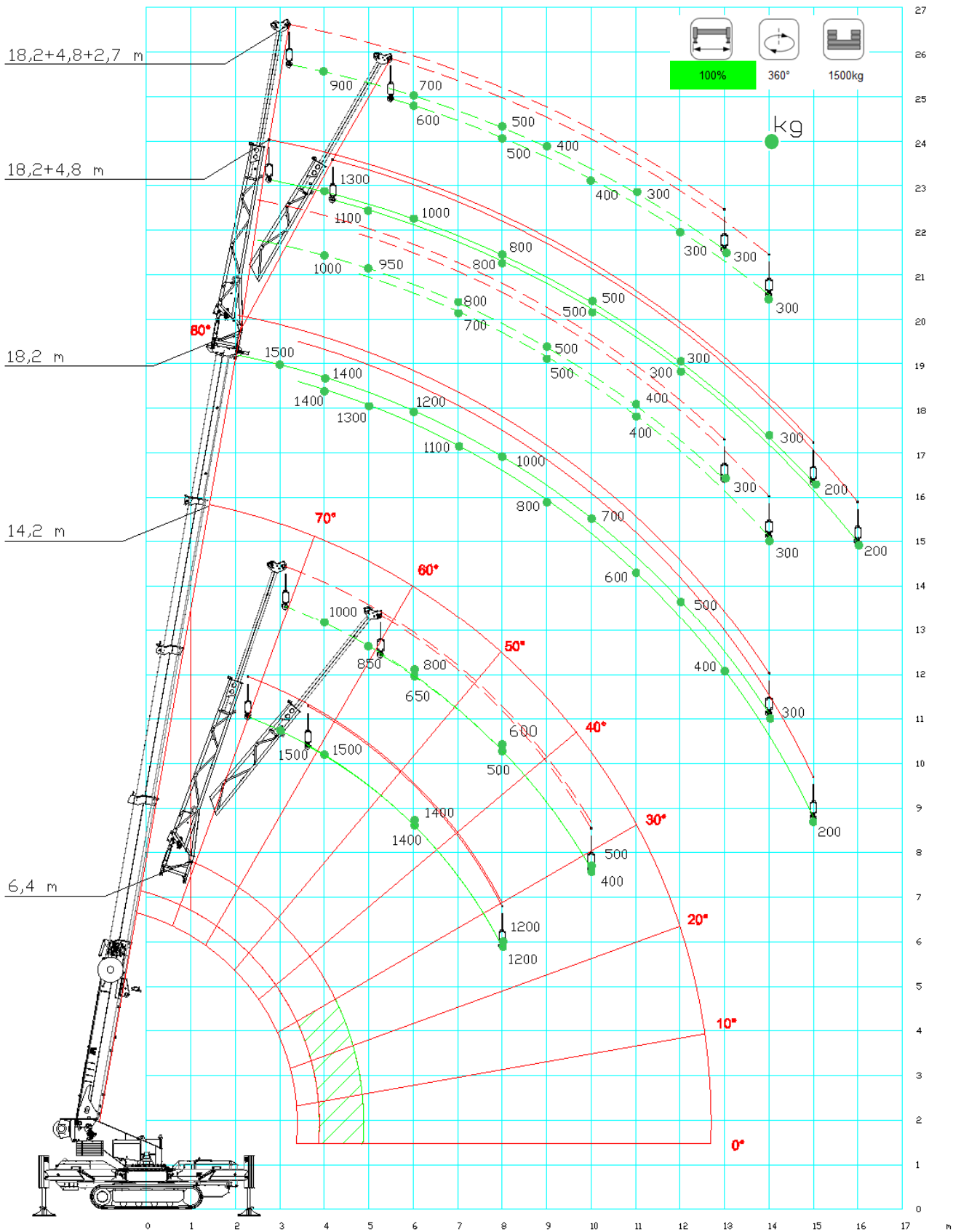
## SPX1275CDH + JIB1500.1FL



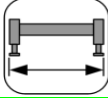
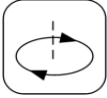
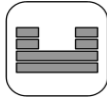

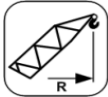

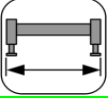
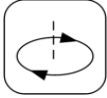

[m] [kg]						
	JIB1500.1FL	100%	360°	1500kg		
	6,4 + 4,8		14,2 + 4,8		18,2 + 4,8	
	0°	25°	0°	25°	0°	25°
3,0	1500		1500			
4,0	1500	1500	1400	1400	1300	
5,0	1500	1500	1300	1300	1100	1100
6,0	1400	1400	1200	1200	1000	1000
7,0	1300	1300	1100	1100	900	900
8,0	1200	1200	1000	1000	800	800
9,0			800	800	600	600
10,0			700	700	500	500
11,0			600	600	400	400
12,0			500	500	300	300
13,0			400	400	300	300
14,0			300	300	300	300
15,0				200	200	200
16,0						200

LC 1275\_V200\_0715\_JIB\_0deg\_STAB\_100

LC 1275\_V200\_0715\_JIB\_25deg\_STAB\_100

[m] [kg]						
	JIB1500.1FL + STINGER	100%	360°	1500kg		
	6,4 + 4,8 + 2,7		14,2 + 4,8 + 2,7		18,2 + 4,8 + 2,7	
	0°	25°	0°	25°	0°	25°
4,0	1000		1000			
5,0	850		950		800	
6,0	800	650	900	800	700	600
7,0	650	550	800	700	600	600
8,0	600	500	600	600	500	500
9,0	550	450	500	500	400	400
10,0	500	400	500	500	400	400
11,0			400	400	300	300
12,0			300	300	300	300
13,0			300	300	300	300
14,0				300		300

LC 1275\_V200\_0715\_STINGER\_0deg\_STAB\_100

LC 1275\_V200\_0715\_STINGER\_25deg\_STAB\_100

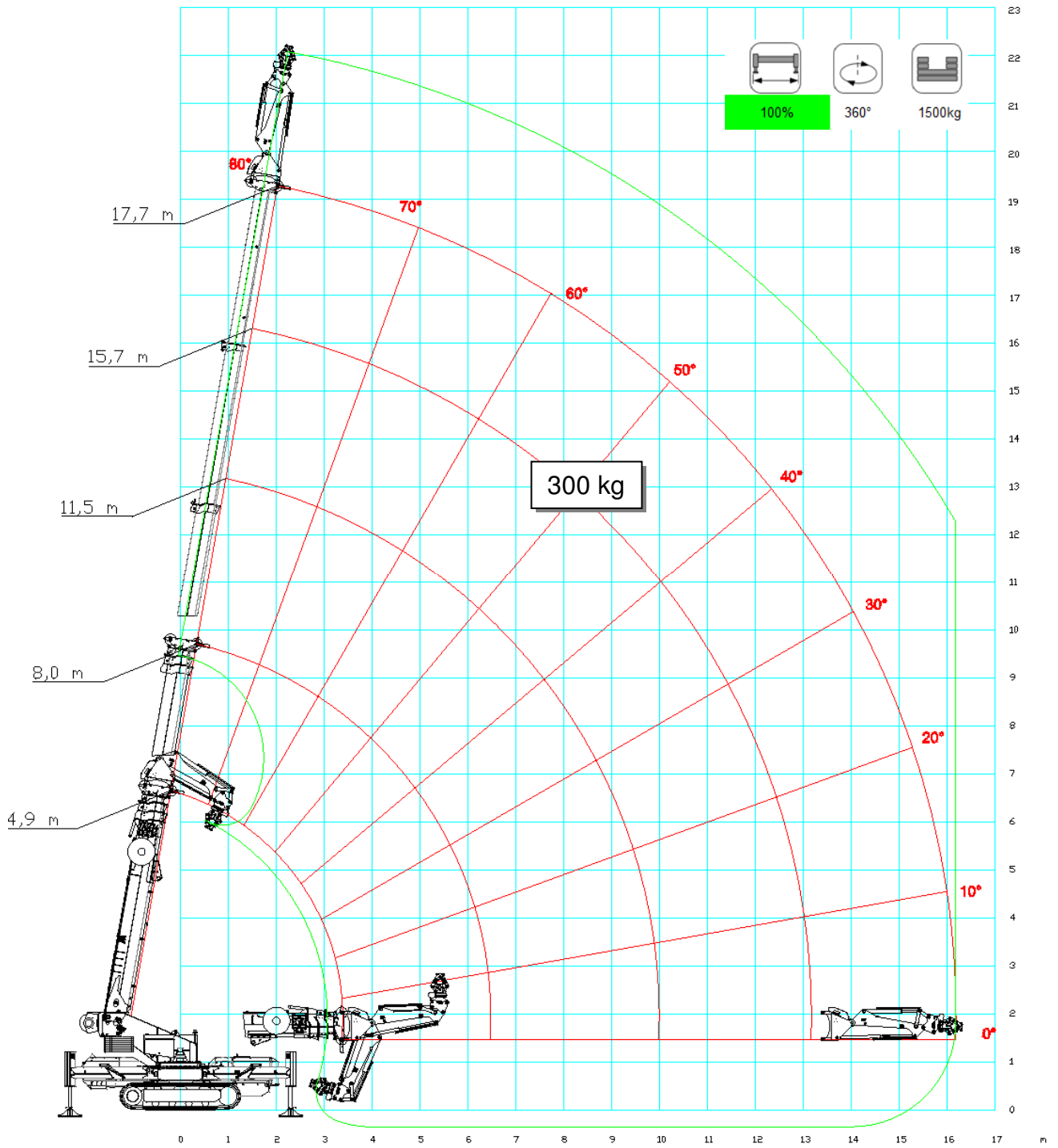
**SPX1275CDH + JIB300GR**

## SPX1275CDH + JIB300GR

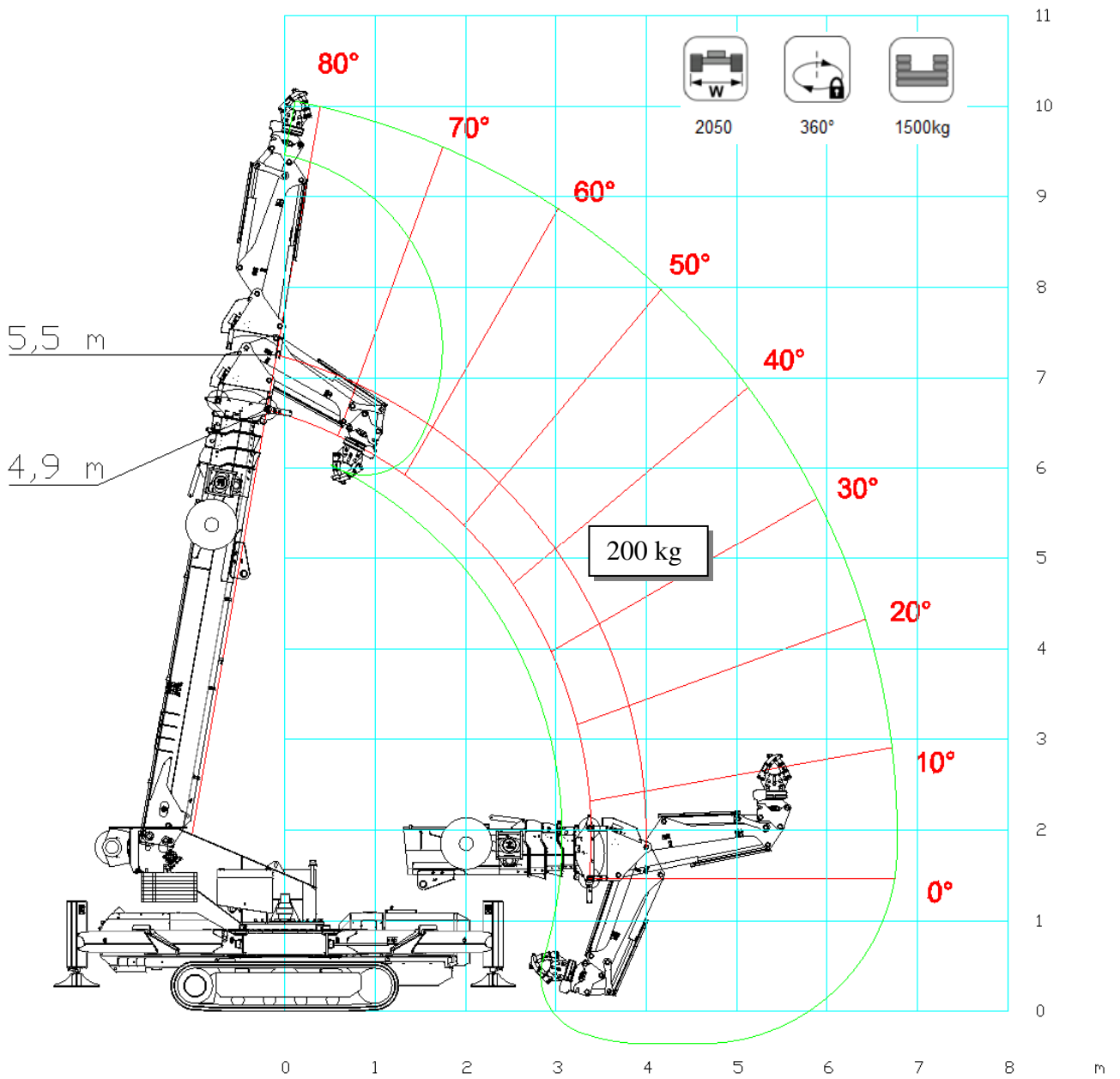



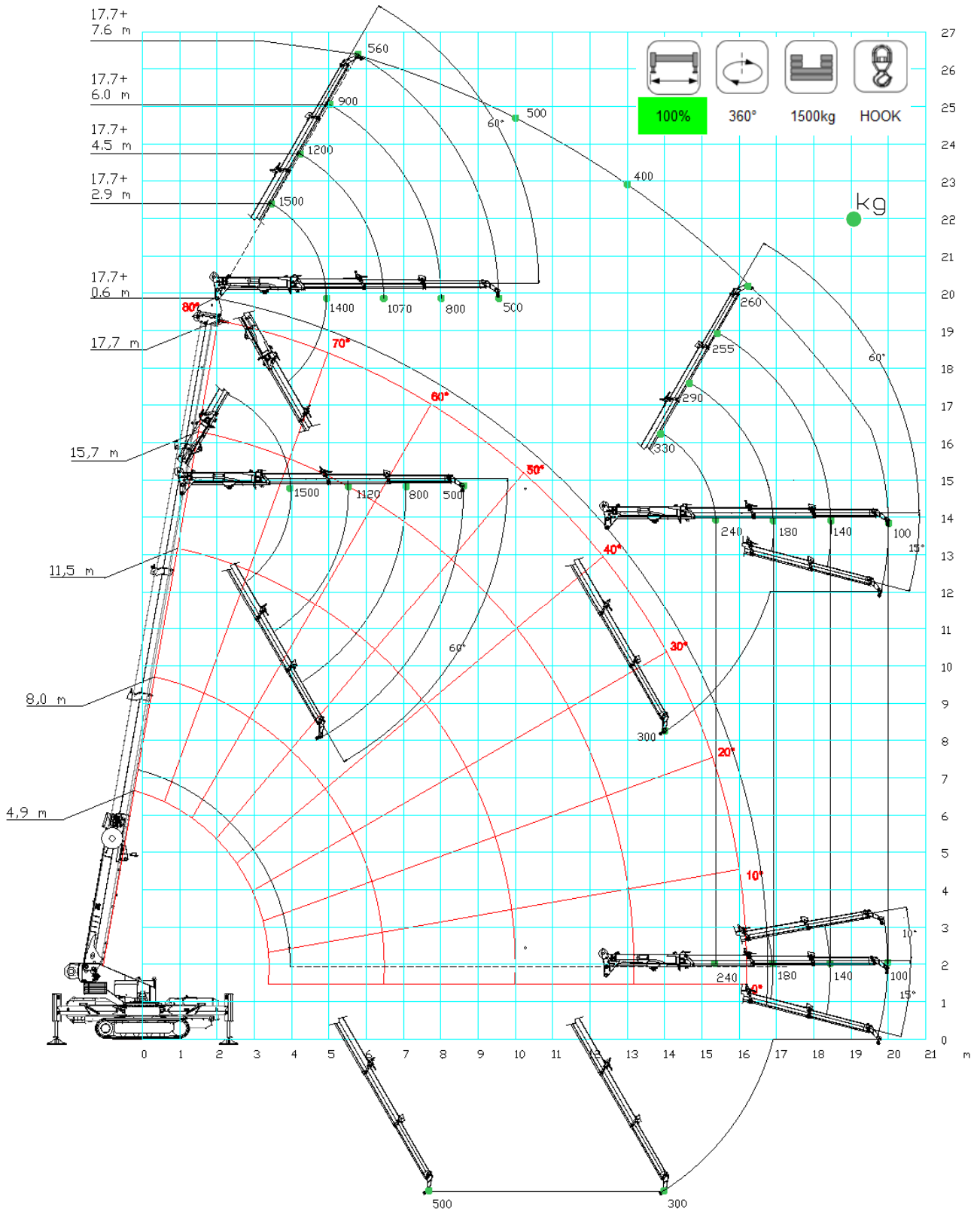

## SPX1275CDH + JIB1500.3HL

### HOOK MODE

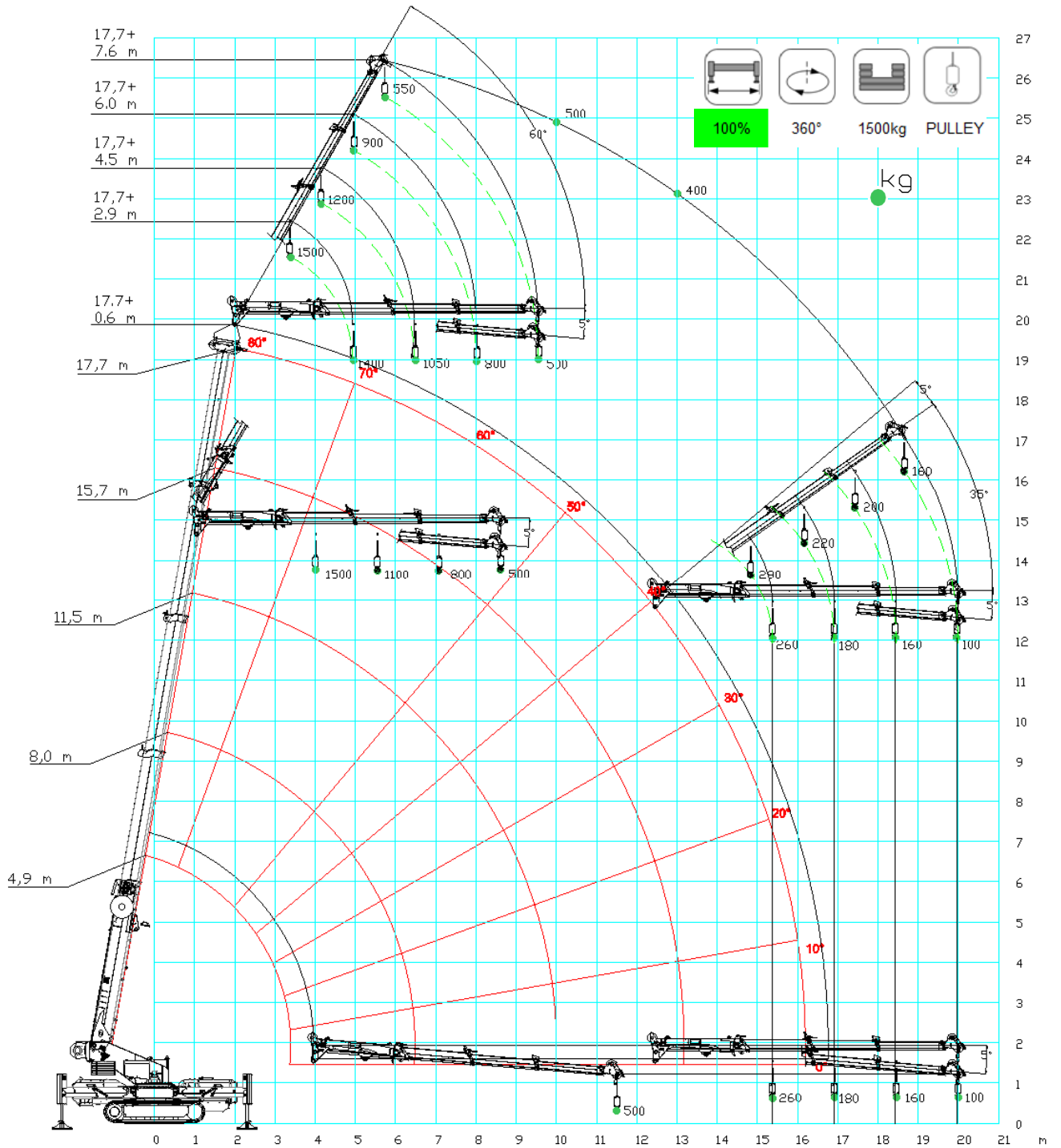

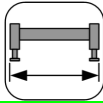
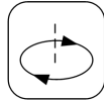
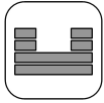

## PULLEY MODE

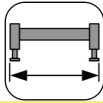
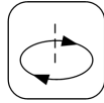
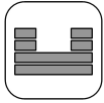

[m] [kg]					EN
	JIB1500.3HL	100%	360°	1500kg	
	2,93	4,47	6,01	7,55	
2,0	1500				
3,0	1500	1200	950	650	
4,0	1500	1200	950	650	
5,0	1400	1150	900	600	
6,0	1300	1100	850	550	
7,0	1200	1050	800	500	
8,0	1100	1000	800	500	
9,0	1000	900	800	500	
10,0	900	800	700	500	
11,0	800	700	600	500	
12,0	600	580	550	500	
13,0	460	440	420	400	
14,0	330	320	310	300	
15,0	280	280	275	270	
16,0	200	220	240	260	
17,0	120	180	210	240	
18,0		110	170	210	
19,0			110	140	
20,0				100	

LC 1275\_V200\_0715\_JIB 1500\_3H\_CW\_1500\_STAB\_100

[m] [kg]					EN
	JIB1500.3HL	50%	360°	1500kg	
	2,93	4,47	6,01	7,55	
2,0	1500				
3,0	1500	1000	800	500	
4,0	1400	1000	800	500	
5,0	1300	1000	800	500	
6,0	1000	1000	800	500	
7,0	800	700	600	500	
8,0	600	550	500	450	
9,0	400	400	400	400	
10,0	250	250	250	250	
11,0	120	120	120	120	

LC 1275\_V200\_0715\_JIB 1500\_3H\_CW\_1500\_STAB\_50





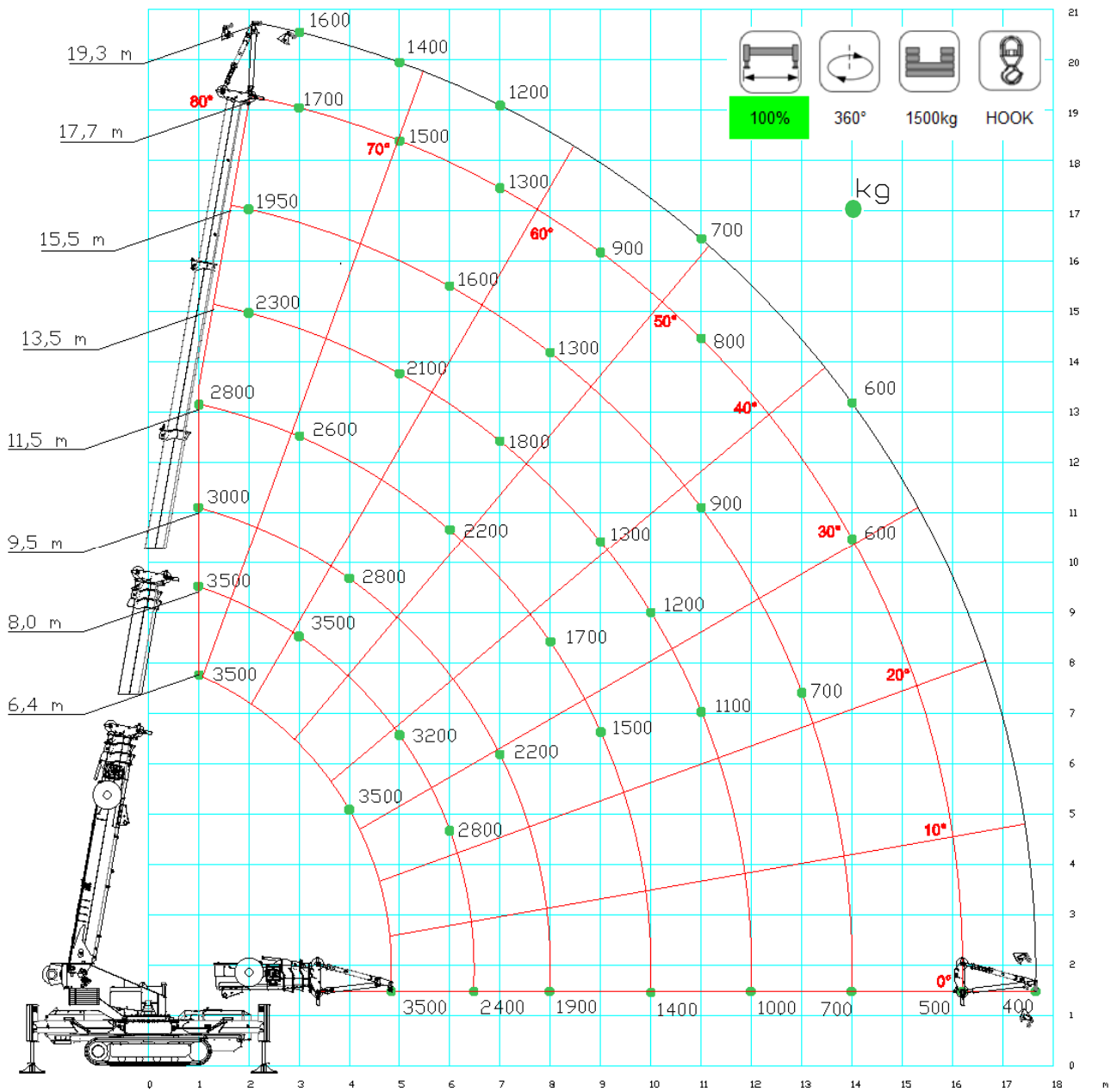

**JIB3500G**
**HOOK MODE**

[m] [kg]								
	JIB3500G	100%	360°	1500kg	HOOK			
	6,4	8,0	9,5	11,5	13,5	15,5	17,7	19,3
1,0	3500	3500	3000	2800				
2,0	3500	3500	2900	2600	2300	1950	1800	1600
3,0	3500	3500	2900	2600	2200	1900	1700	1600
4,0	3500	3400	2800	2500	2150	1800	1600	1500
5,0		3200	2600	2350	2100	1700	1500	1400
6,0		2800	2400	2200	2000	1600	1400	1300
7,0			2200	2100	1800	1450	1300	1200
8,0			1900	1700	1500	1300	1100	1000
9,0				1500	1300	1100	900	800
10,0				1400	1200	1000	800	750
11,0					1100	900	800	700
12,0					1000	800	700	650
13,0						700	650	650
14,0						700	600	600
15,0							600	550
16,0							500	450
17,0								430
17,7								400

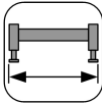
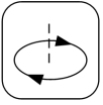
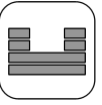

LC1275\_V200\_0715\_RUNNER\_7deg\_CW1500\_G\_STAB\_100

[m] [kg]								
	JIB3500G	100%	360°	0kg	HOOK			
	6,4	8,0	9,5	11,5	13,5	15,5	17,7	19,3
1,0	3500	3500	3000	2800				
2,0	3500	3500	2900	2500	2000	1500	1400	1300
3,0	3200	3000	2800	2300	1800	1400	1300	1200
4,0	2500	2300	2000	1800	1600	1350	1200	1100
5,0		2200	1800	1600	1400	1300	1100	1000
6,0		2000	1600	1400	1200	1100	1000	900
7,0			1500	1300	1100	1000	900	800
8,0			1300	1100	1000	900	800	700
9,0				1000	900	800	700	600
10,0				900	800	700	600	550
11,0					700	650	600	500
12,0					600	550	500	450
13,0						500	450	400
14,0						500	400	350
15,0							350	300
16,0							260	240
17,0								220
17,7								200

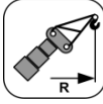
LC1275\_V200\_0715\_RUNNER\_7deg\_CW0\_G\_STAB\_100

[m] [kg]								
	JIB3500G	50%	360°	1500kg	HOOK			
	6,4	8,0	9,5	11,5	13,5	15,5	17,7	19,3
1,0	3500	3500	3000	2800				
2,0	3200	3200	2900	2600	2300	1200	1100	1000
3,0	1800	1600	1500	1400	1200	1100	950	900
4,0	1700	1600	1400	1250	1000	900	850	800
5,0		1600	1300	1200	950	850	800	750
6,0		1500	1300	1100	900	800	750	700
7,0			1200	1000	850	750	700	650
8,0			1000	800	750	600	550	500
9,0				700	600	520	460	400
10,0				600	580	500	440	380
11,0					560	450	420	360
12,0					550	450	400	350
13,0						400	350	330
14,0						330	320	300
15,0							300	230
16,0							250	220
17,0								210
17,7								200

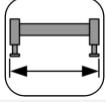
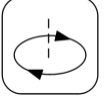
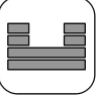
LC1275\_V200\_0715\_RUNNER\_7deg\_CW1500\_G\_STAB\_50

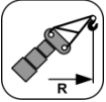
[m] [kg]						EN
	JIB3500G	50%	360°	0kg	HOOK	
	6,4	8,0	9,5	11,5	13,5	
1,0	3500	3500	3000	2800		
2,0	3200	3200	2900	2400	1800	
3,0	1800	1700	1600	1500	1400	
4,0	1700	1600	1400	1200	1100	
5,0		1400	1300	1200	1000	
6,0		1100	1000	900	800	
7,0			800	700	600	
8,0			700	600	500	
9,0				500	400	
10,0				350	300	
11,0					250	
12,0					200	

LC1275\_V200\_0715\_RUNNER\_7deg\_CW0\_G\_STAB\_50



## PULLEY MODE

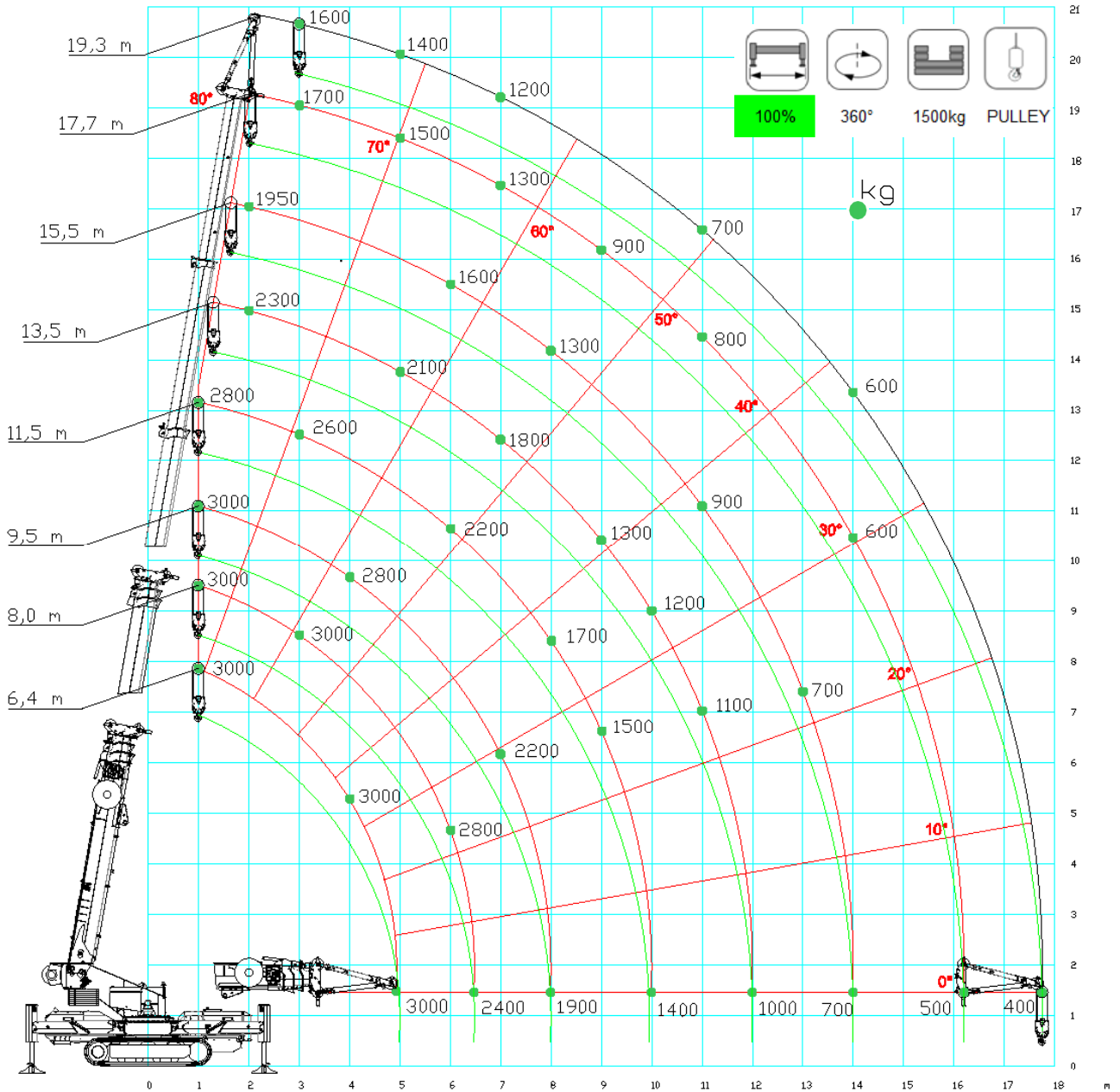



[m] [kg]								
	JIB3500G	100%	360°	1500kg	PULLEY			
	6,4	8,0	9,5	11,5	13,5	15,5	17,7	19,3
1,0	3000	3000	3000	2800				
2,0	3000	3000	2900	2600	2300	1950		
3,0	3000	3000	2900	2600	2200	1900	1700	1600
4,0	3000	3000	2800	2500	2150	1800	1600	1500
5,0		3000	2600	2350	2100	1700	1500	1400
6,0		2800	2400	2200	2000	1600	1400	1300
7,0			2200	2100	1800	1450	1300	1200
8,0			1900	1700	1500	1300	1100	1000
9,0				1500	1300	1100	900	800
10,0				1400	1200	1000	800	750
11,0					1100	900	800	700
12,0					1000	800	700	650
13,0						700	650	650
14,0						700	600	600
15,0							600	550
16,0							500	450
17,0								430
17,7								400

LC1275\_V200\_0715\_RUNNER\_7deg\_CW1500\_STAB\_100

[m] [kg]								
	JIB3500G	100%	360°	0kg	PULLEY			
	6,4	8,0	9,5	11,5	13,5	15,5	17,7	19,3
1,0	3000	3000	3000	2800				
2,0	3000	3000	2900	2500	2000	1500	1400	1300
3,0	3000	3000	2800	2300	1800	1400	1300	1200
4,0	2500	2300	2000	1800	1600	1350	1200	1100
5,0		2200	1800	1600	1400	1300	1100	1000
6,0		2000	1600	1400	1200	1100	1000	900
7,0			1500	1300	1100	1000	900	800
8,0			1300	1100	1000	900	800	700
9,0				1000	900	800	700	600
10,0				900	800	700	600	550
11,0					700	650	600	500
12,0					600	550	500	450
13,0						500	450	400
14,0						500	400	350
15,0							350	300
16,0							260	240
17,0								220
17,7								200

LC1275\_V200\_0715\_RUNNER\_7deg\_CW0\_STAB\_100

[m] [kg]								
	JIB3500G	50%	360°	1500kg	PULLEY			
	6,4	8,0	9,5	11,5	13,5	15,5	17,7	19,3
1,0	3000	3000	3000	2800				
2,0	3000	3000	2900	2600	2300	1200	1100	1000
3,0	1800	1600	1500	1400	1200	1100	950	900
4,0	1700	1600	1400	1250	1000	900	850	800
5,0		1600	1300	1200	950	850	800	750
6,0		1500	1300	1100	900	800	750	700
7,0			1200	1000	850	750	700	650
8,0			1000	800	750	600	550	500
9,0				700	600	520	460	400
10,0				600	580	500	440	380
11,0					560	450	420	360
12,0					550	450	400	350
13,0						400	350	330
14,0						330	320	300
15,0							300	230
16,0							250	220
17,0								210
17,7								200

LC1275\_V200\_0715\_RUNNER\_7deg\_CW1500\_STAB\_50

[m] [kg]							EN
		JIB3500G	50%	360°	0kg	PULLEY	
		6,4	8,0	9,5	11,5	13,5	
1,0		3000	3000	3000	2800		
2,0		3000	3000	2900	2400	1800	
3,0		1800	1700	1600	1500	1400	
4,0		1700	1600	1400	1200	1100	
5,0			1400	1300	1200	1000	
6,0			1100	1000	900	800	
7,0				800	700	600	
8,0				700	600	500	
9,0					500	400	
10,0					350	300	
11,0						250	
12,0						200	

LC1275\_V200\_0715\_RUNNER\_7deg\_CW0\_STAB\_50

## ACCESSORIES

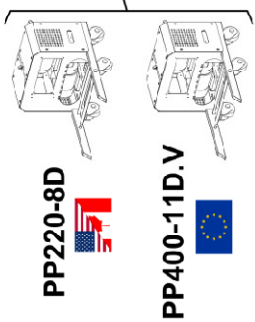
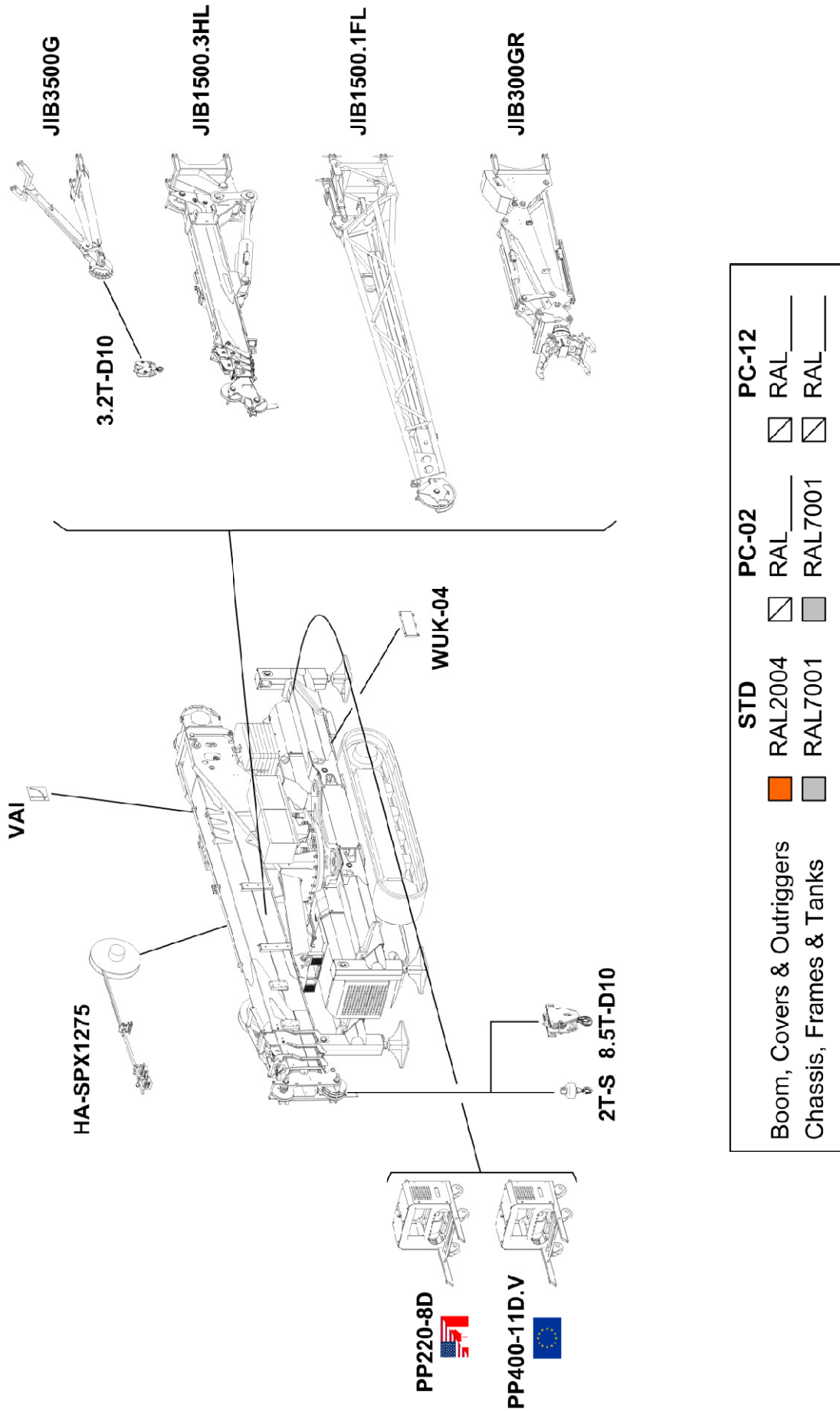

	STD	PC-02	PC-12
Boom, Covers & Outriggers	<input type="checkbox"/> RAL2004	<input type="checkbox"/> RAL_____	<input type="checkbox"/> RAL_____
Chassis, Frames & Tanks	<input type="checkbox"/> RAL7001	<input checked="" type="checkbox"/> RAL7001	<input checked="" type="checkbox"/> RAL_____

**ACCESSORIES FEATURES**

**JIB1500.1FL**

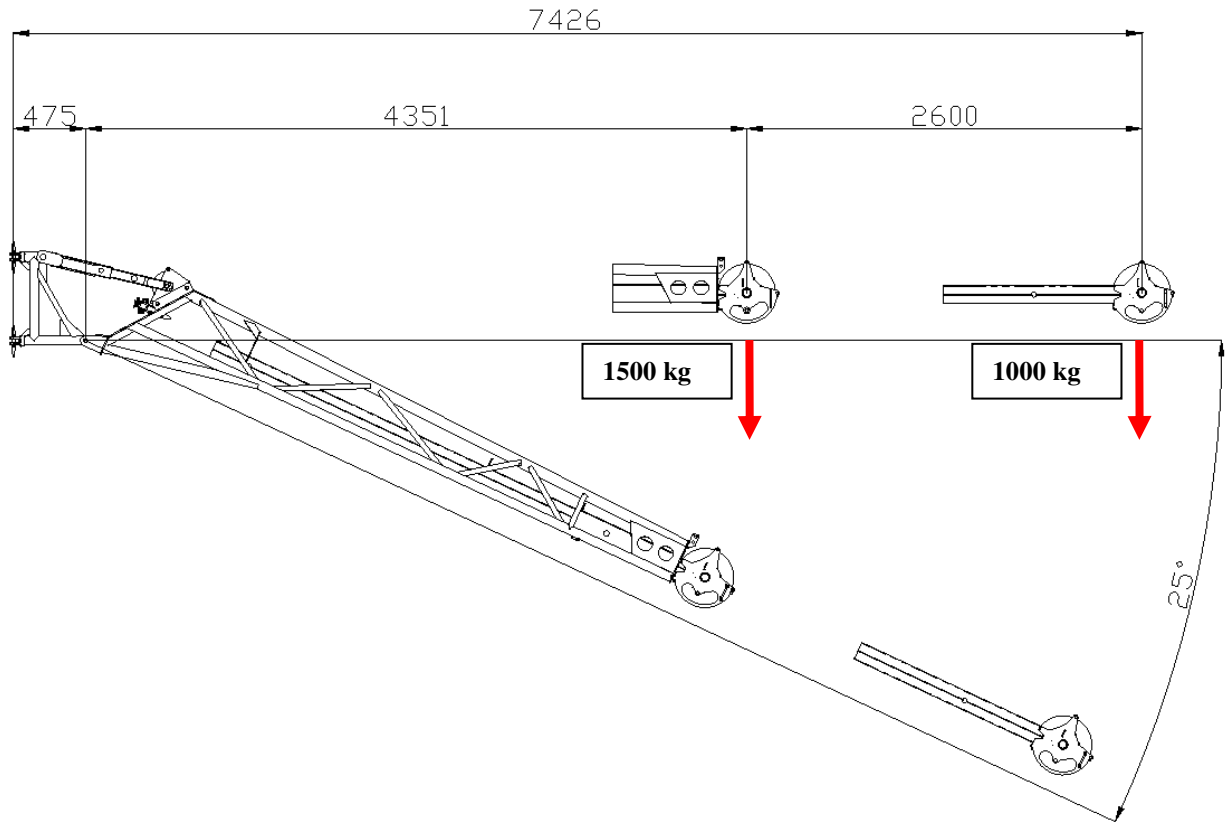

	kg
	265

**JIB1500.3HL**

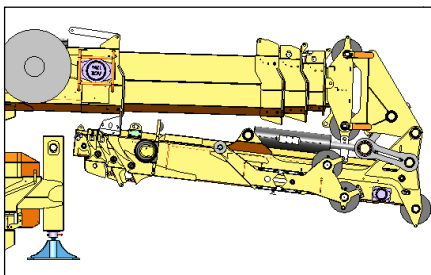
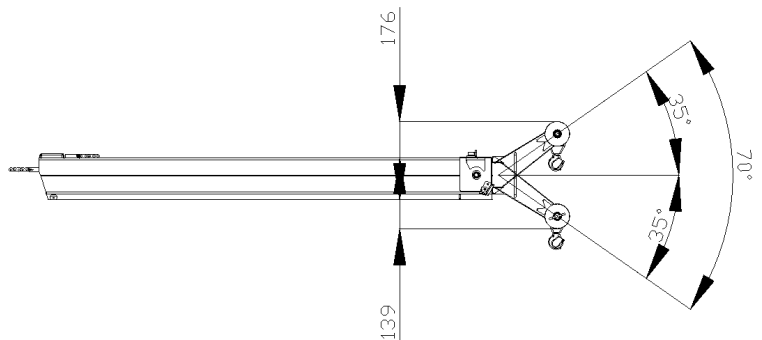
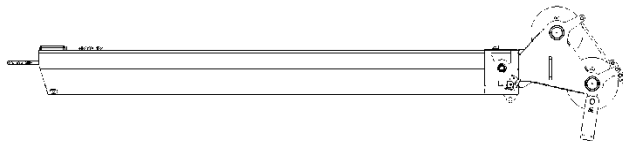
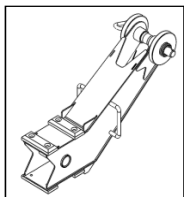
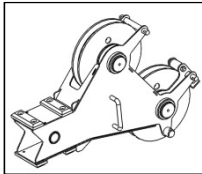
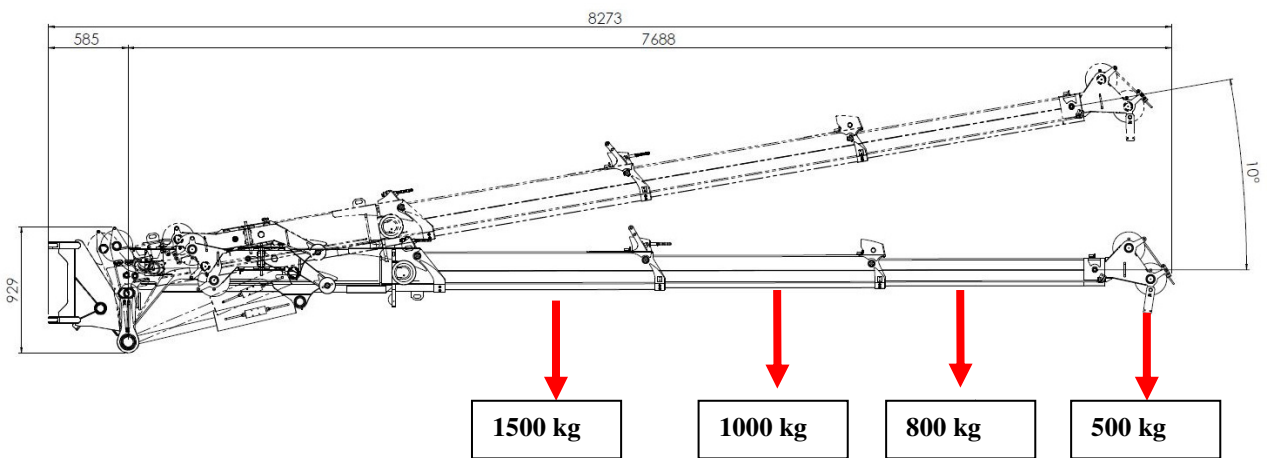
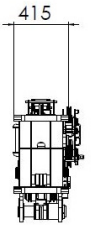
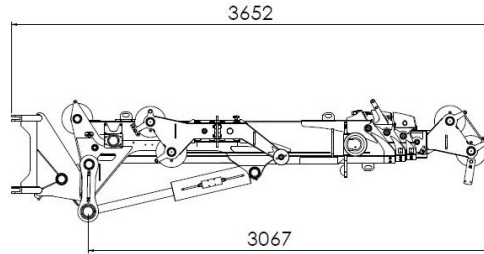
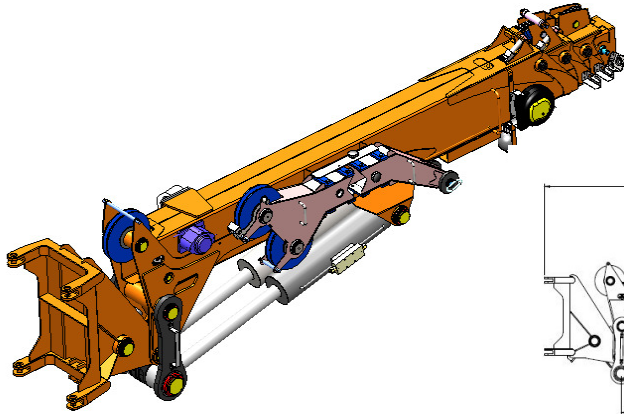

**Fast out of service position**

	kg
	480

**JIB3500G**

**HOOK (3,5Ton)**

**Up position  
(33°)**

**Middle position  
(7°)**

**Down position  
(-21°)**

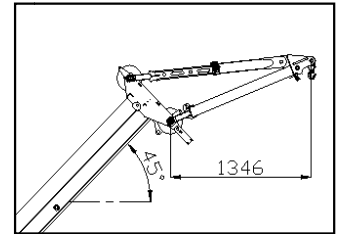
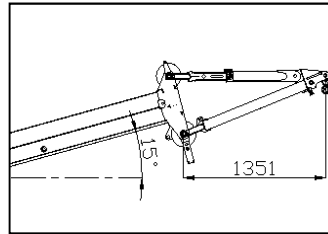
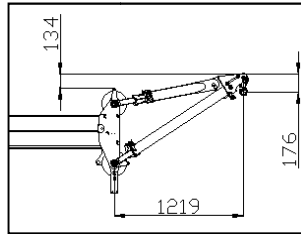

**PULLEY (3,0Ton)**

**Middle position  
(7°)**

**Down position  
(-21°)**

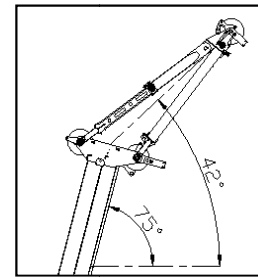
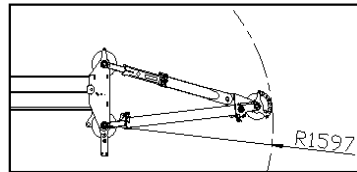

**OUT SERVICE CONFIGURATION**

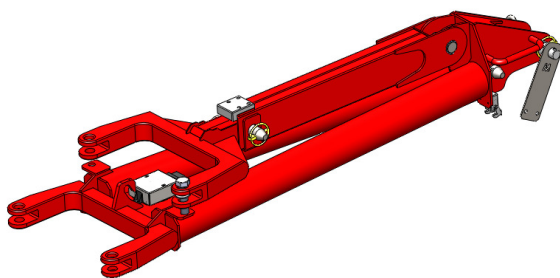

	kg
	70



**JIB300GR**

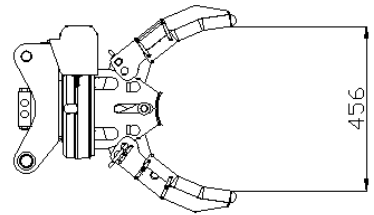
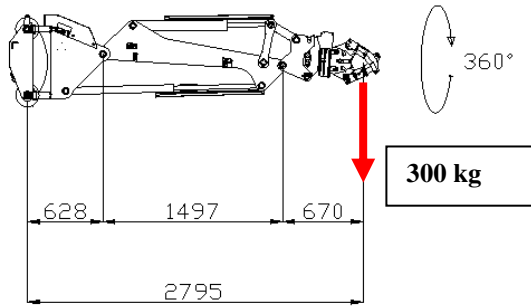
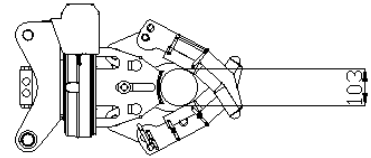
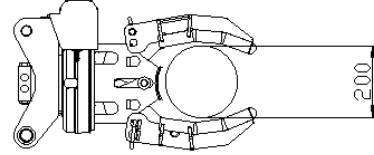
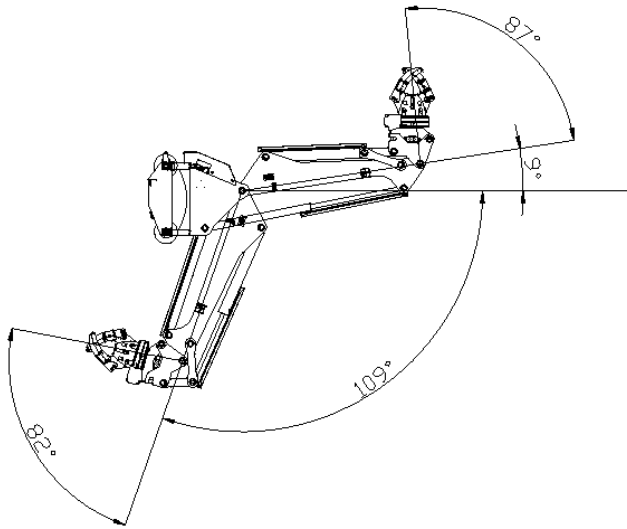

	kg
	245

# SYMBOLS

	Weight		Chart Wheels		Engine		Jib length and angle
	Counterweight		Minipicker		Diesel Fuel		Jib Length
	Crane		Back Wheel Point Loading		Gasoline Fuel		Jib Radius
	Travel Speed		Front wheel Point Loading		Tank		Hydraulic Jib Length
	Gradeability		Travel Speed		Battery		Hydraulic Jib Radius
	Outtrigger Load		Gradeability		Power		Mechanical Jib Length
	Track Loading		Working Radius		Boom Angle		Mechanical Jib Radius
	Outriggers Setup		Hookblock		Boom Length		Manipulator Length
	Ext Tracks Width		Slewing		Boom Radius		Manipulator Radius
	Chart On Tracks		Slewing Locked		Jib Hook Radius		Maximum inclination of the machinery
	Jib on board		Without jib on board		Standard		Stabilizing bar
	Horizontal boom angle		Number of vacuum pads		Factory max. load		Building site max. load

## Remarks referring to load chart

- The load charts are calculated according to EN 13000.
- For the calculation of the load charts at least a wind speed of 9m/s (33km/h) and regarding the load a sail area of 1m<sup>2</sup> per ton load and a wind resistance coefficient of 1.2 on the load have been taken into account. For lifting of loads with large sail areas and/or high wind resistance coefficients the maximum wind speed as stated in the load charts has to be reduced.
- Lifting capacities are given in kilograms.
- The weight of the hook blocks and hooks is part of the load and therefore it must be deducted from the lifting capacities.
- Working radii are measured from the slewing centre.
- The lifting capacities given for the telescopic boom apply if the folding jib is removed.
- Subject to modification of lifting capacities.



NOTES

A large, empty rectangular box with a thin black border, intended for handwritten notes.



DEALER



JEKKO S.r.l. via Campardone, 1 Z.I. 31014 Colle Umberto (TV)  
Italy tel. +39 0438 1710083 fax +39 0438 1710123  
[www.jekko.it](http://www.jekko.it) - [info@jekko.it](mailto:info@jekko.it)