

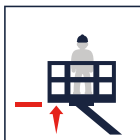

## SMX250



25,20 m



23,20 m

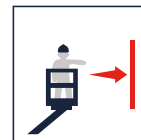

7,90 m (250 kg)  
11,60 m (80 kg)



250 kg

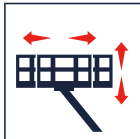

1400x700x1100 mm



90°+90°



360°



KUBOTA  
10,9kW/ 3200 rpm



2,2 kW/ 230 V  
50 hz/ 1500 rpm



 1,2 km/h  
 2,4 km/h



14°/25%



2660 kg

# SMX250

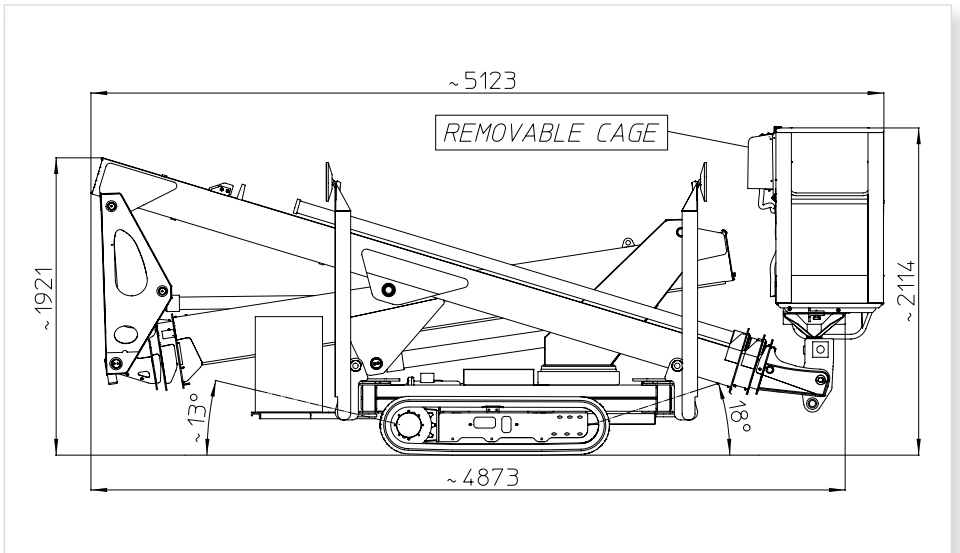
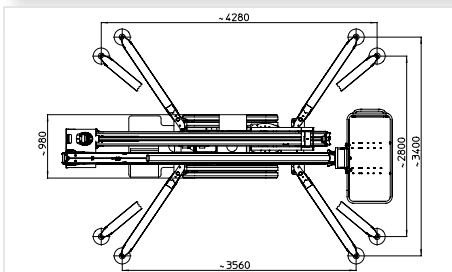
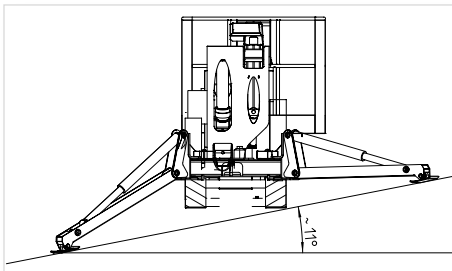
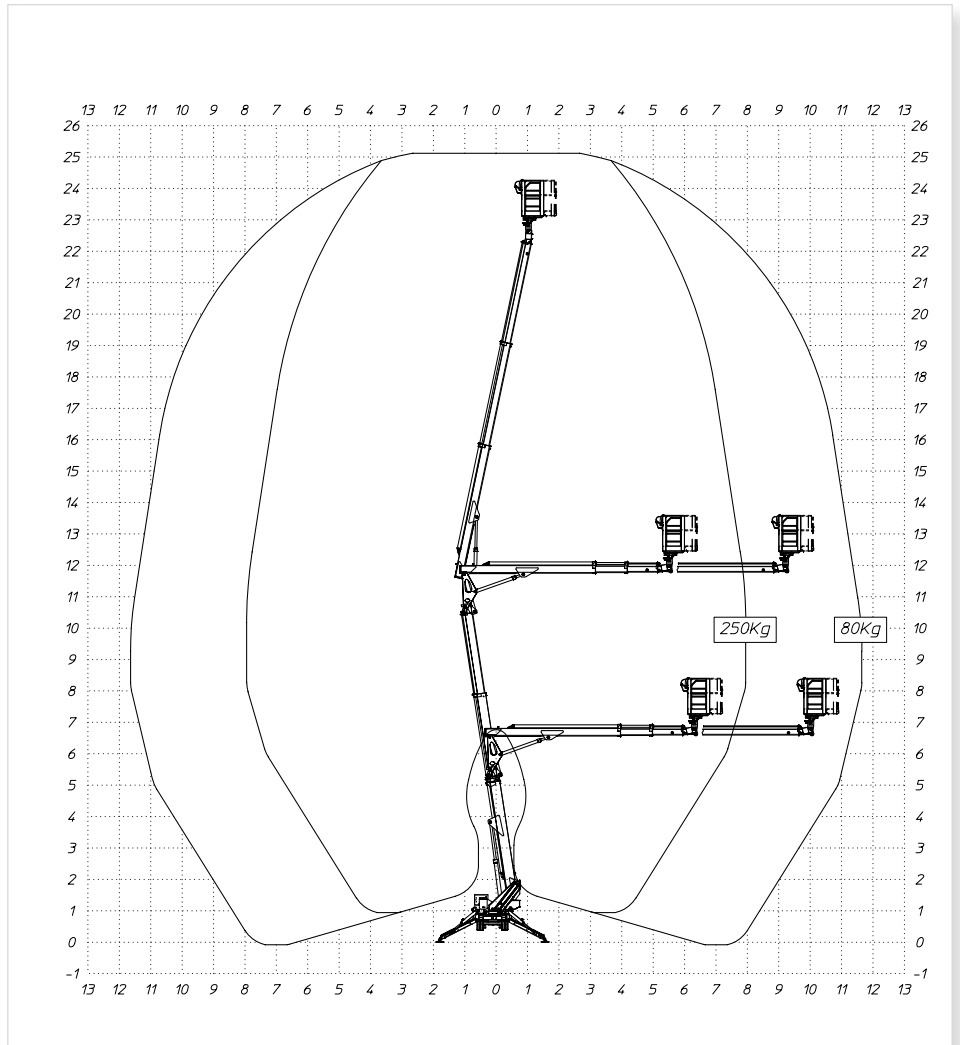
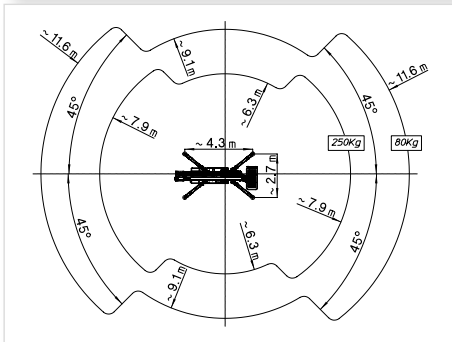
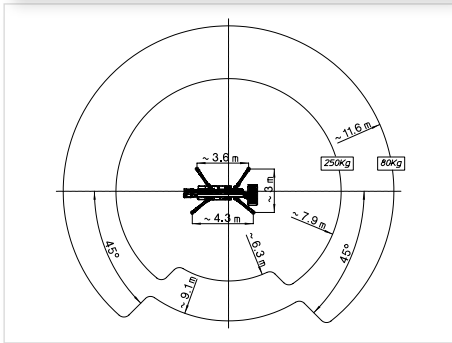
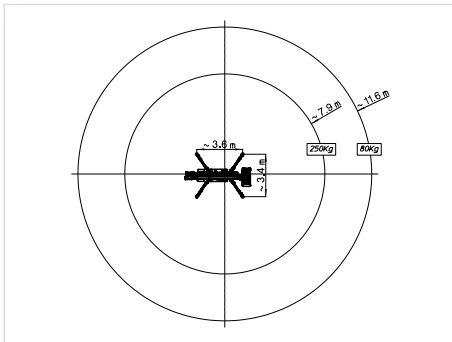

## MULTITEL PAGLIERO S.P.A.

Strada Statale, 114  
12030 MANTA (CN) - ITALY  
Tel. +39 0175 255211- Fax +39 0175 255255  
info@pagliero.com

## Filiali

Corso Piemonte, 54  
10099 S.MAURO T.SE(TO) - ITALY  
Tel. +39 011 2236792 - Fax +39 011 2236761

Via dell'Offelera, 106  
20861 BRUGHERIO (MB) - ITALY  
Tel. +39 039 883393/4 - Fax +39 039 2872140

## MULTITEL INTERNATIONAL SAS

87, rue du Morellon  
38070 ST. QUENTIN FALLAVIER - FRANCE  
Tel. +33 (0)4 74 94 63 19 - Fax +33 (0)4 74 94 46 97  
info@multitelinternational.com

## MULTITEL EXPORT SALES GmbH

Carl-Zeiss-Straße, 34  
52477 ALSDORF - DEUTSCHLAND  
Tel. +49 (0) 2404 675 580 - Fax +49 (0) 2404 675 58 29  
export@pagliero.com

## MULTITEL UK Ltd

c/o Simmons Gainsford  
7/10 Chandos Street, Cavendish Square - London W1G 9DQ  
info.uk@pagliero.com

[www.multitelgroup.com](http://www.multitelgroup.com)